

L1 PRO

PORTABLE LINE ARRAY SYSTEMS

Application Guide



L1 PRO8

The most portable
L1 Pro system



L1 PRO16

A balance of power
and portability



L1 PRO32 with SUB1

The most advanced
L1 ever



or



SUB2



L1 MIX

for Apple &
Android devices

PORTFOLIO LINEUP	1	L1 PRO32 + SUB1	14
L1 PRO ONBOARD MIXER	3	L1 PRO32 + SUB2	15
L1 PRO MIX APP.....	4	SUB1 SUB2.....	16
BLUETOOTH CONNECTIONS.....	5	CARDIOID SUBS EXPLAINED.....	18
RACETRACK DRIVER	6	CARDIOID CONFIGURATION.....	19
POWERFUL INTEGRATED PERFORMANCE	6	VENUE RECOMMENDATION	20
LINE ARRAY TECHNOLOGY.....	7	CONNECTION DIAGRAM	21
THE ADVANTAGES.....	7	L1 PRO8 SYSTEM DIAGRAM EXAMPLE	22
DIRECTS SOUND TO FARTHER DISTANCES.....	8	L1 PRO16 SYSTEM DIAGRAM EXAMPLE.....	23
OVERCOMES CHALLENGING ENVIRONMENTS.....	9	L1 PRO32 SYSTEM DIAGRAM EXAMPLE	24
SLIM ADAPTABLE DESIGN.....	10	L1 PRO32 SYSTEM DIAGRAM EXAMPLE 2.....	25
SELECTION GUIDE.....	11	TONEMATCH.....	26
L1 PRO8	12	ACCESSORIES.....	27
L1 PRO16.....	13		





L1 PRO8
With Integrated
Subwoofer

L1 PRO16
With Integrated
Subwoofer

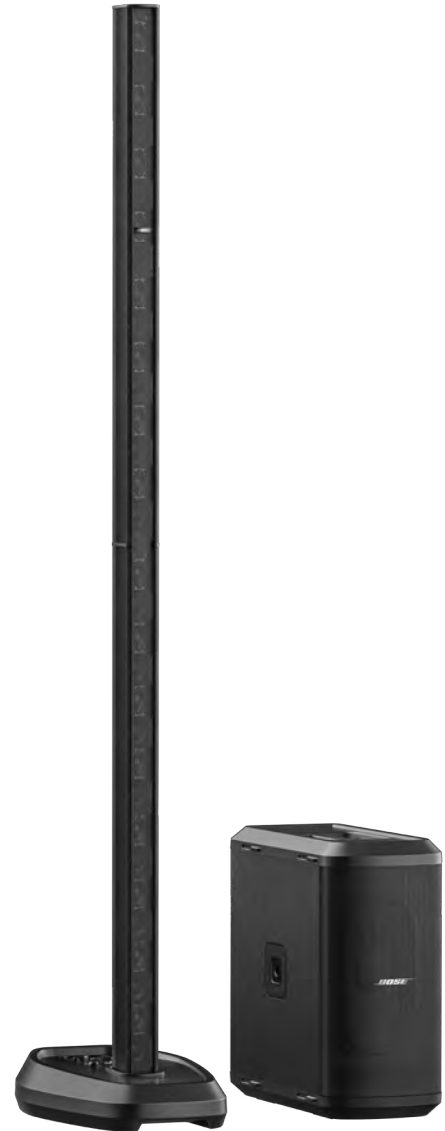

L1 PRO32 + SUB1
With Modular
Subwoofer



L1 Mix App
Mobile device not included
and not to scale

L1 PRO32 + SUB2
With Modular
Subwoofer

Dialed in for pure performance

L1 Pro portable line array systems advance a PA category invented by Bose into a new era of on-the-go audio for singer-songwriters, mobile DJs, and bands.

Three models offer legendary 180-degree horizontal coverage, unmatched clarity and tonal balance, plus extended bass response with a unique RaceTrack woofer design.

Built-in multi-channel mixers offer EQ, reverb, and phantom power, plus Bluetooth® streaming and access to the full library of ToneMatch presets.

Bass without the bulk

Unique RaceTrack woofers integrated into the L1 Pro8 and L1 Pro16 — and in the Bose Sub1 and Sub2 modular subwoofers available for the L1 Pro32 — deliver powerful bass, have an optimized center of gravity, and save a lot of space.

This slim design means you get the full impact of a conventional subwoofer without the cumbersome size, freeing up room in your vehicle and on the stage, and making every carry in between — home to car, vehicle to venue — much easier.

Mixer onboard... and on your phone

Each L1 Pro system features a built-in mixer, so you can connect various instruments, microphones, and other sources easily. You get two combo XLR-1/4" phantom-powered inputs, 1/4" and 1/8" (3.5 mm) aux inputs, plus Bluetooth® streaming capability.

Illuminated rotary encoders give you instant access to volume, tone, and reverb settings per channel. Select between optimized system EQ presets for live music, recorded music, and more.

Add in even more instruments and other audio sources via dedicated ToneMatch port — one cable provides both power and digital audio between the system and a Bose T4S or T8S mixer (optional).

The L1 Mix app provides channel-level mixer control...

Intuitive and instant wireless control

With the L1 Mix app, you can adjust mixer settings instantly from your phone or even walk the room, hear how the mix sounds, and fine-tune as you go.

Change volume and tone settings in the app and watch the LED encoder on your L1 Pro move to match — the mixer and app are always in sync, in real time.

Plus, you have access to the entire ToneMatch library of custom EQ presets. With the L1 Mix app, you get the connectivity that empowers your performance, giving you greater flexibility for on-the-fly tweaks via controls that are intuitive and instant.

All for that moment

Premium sound on stage. Practical portability everywhere else. With an L1 Pro system, you can get from parking to performing with ease and from setup to setlist in minutes. It's the power to sound your best and simply perform.

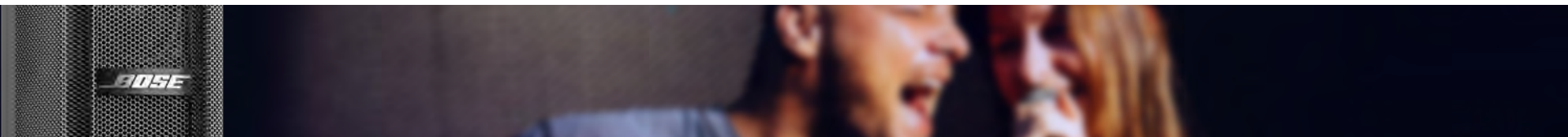



- 1 **Illuminated digital rotary encoders** adjusts the level of volume, treble, bass, or reverb for your desired channel. Press the control to switch between parameters; rotate the control to adjust the level of your selected parameter.
- 2 **Signal/clip LED indicator** illuminates green when a signal is present and will illuminate red when the signal is clipping.
- 3 **Channel mute** by pressing the button. While muted, the switch will illuminate white.
- 4 **Channel ToneMatch button** selects the ToneMatch preset for an individual channel. Use MIC for microphones and INST for acoustic guitar. The corresponding LED will illuminate white while selected. It will illuminate green when a custom preset is selected in the L1 Mix app.
- 5 **Combination input jack** accepts analog input for connecting microphone (XLR) and instrument (1/4-inch TRS or TS) cables.
- 6 **Phantom power** provides 48-volt power to channels 1 and 2. The LED will illuminate white while phantom power is applied.
- 7 **USB-C port** for firmware updates and Bose service.
- 8 **XLR line output** to connect the line-level output to a Sub1/Sub2 or another bass module.
- 9 **ToneMatch port** connects your L1 Pro8/Pro16/Pro32 to a T4S or T8S ToneMatch mixer via a ToneMatch cable.
- 10 **Bluetooth® pair button** sets up pairing with Bluetooth capable devices, such as mobile phones, tablets, and laptops. The LED will flash blue while the system is discoverable and illuminate solid white when a device is paired for streaming.
- 11 **Aux line input** uses a 3.5-millimeter (1/8-inch) TRS cable to connect a line-level audio source.
- 12 **Line input** uses a 6.4-millimeter (1/4-inch) TRS cable to connect line-level audio sources.
- 13 **System EQ** button scrolls through and selects a master EQ suitable for the use case. The corresponding LED will illuminate white while selected.
- 14 **Standby button** is pressed to power on. The LED will illuminate white while the system is on.



Download the Bose L1 Mix app to your phone or tablet to take wireless control of your L1 Pro system via Bluetooth LE connection. Adjust settings instantly, roam the room and fine-tune, mute the reverb, access the ToneMatch library of custom EQ presets, and stream audio. The L1 Pro system indicators and controls update in real time with changes made in the app.



FEATURES

- Adjust channel mixer parameters -
 - Volume, EQ, reverb, channel mute, reverb mute, phantom power
- Adjust system EQ
- Access ToneMatch preset library
- Save scenes
- Synchronized controls and indicators



Wireless Control and Audio Streaming

L1 Pro Systems include two separate Bluetooth connections: Bluetooth LE and Bluetooth Classic. Each of these type of connections serve a different purpose: control or audio streaming. When you open the L1 Mix app and follow the steps for connecting, your mobile device or tablet connects to the L1 Pro system using Bluetooth LE technology. This allows you to control all functions of the L1 Pro system such as volume, channel EQ, system EQ, and more, but does not stream audio. Streaming audio to an L1 Pro system is facilitated through a Bluetooth Classic connection that uses an AAC codec to achieve a high sound quality while using less data.

Bluetooth LE and Classic connections appear separately in your mobile device. This means you can use a single device for both control and audio streaming, or you can use a dedicated device with the L1 Mix app for control and a second device for audio streaming.

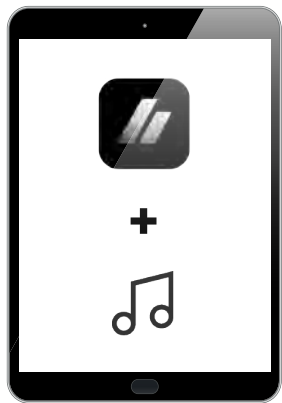

L1 Mix app (Bluetooth LE) + music streaming (Bluetooth Classic)



or



L1 Mix app (Bluetooth LE)

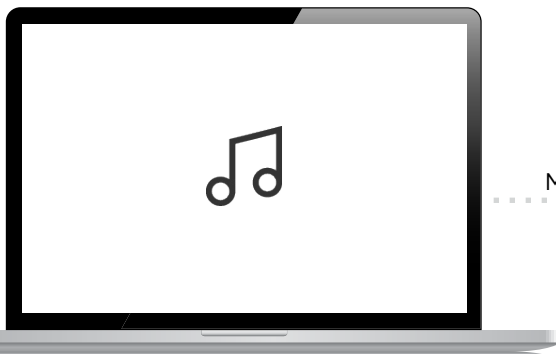

Music streaming (Bluetooth Classic)



Powerful Integrated Performance



Small Beginnings, Massive Performance

Racetrack drivers are most commonly found in small and slim audio applications. Bose has achieved the engineering feat of enlarging the racetrack driver to meet the needs of the traveling performer.

This allows for a slim integrated package to match the performance of a standard larger loudspeaker system.

The proprietary 7" x 13" high-excursion RaceTrack driver found in the Sub1 delivers performance that rivals a traditional 12" loudspeaker without the cumbersome size, freeing up room in your vehicle and on the stage. And the Sub2's 10" x 18" high-excursion RaceTrack driver provides performance similar to a traditional 15" loudspeaker.

Lighter, Stronger, More Durable

The muscle of the RaceTrack driver found in the L1 Pro16 and Sub2 module is the neodymium magnet. This technology allows for a lighter weight and more compact package while retaining the performance you expect. Neodymium magnets have the advantage of being more durable and resistant to demagnetisation than standard ferrite magnets. They can also dissipate heat much faster to maintain consistent performance over longer periods.



L1 PRO8

L1 PRO16

SUB1

SUB2



The Bose L1 Pro series incorporates line array technology that provides advantages compared to a traditional point source portable PA loudspeaker. In general, line array technology provides more targeted audience coverage as it acoustically aims its sound energy to the intended listening area and away from non-intended areas like the ceiling or floors.

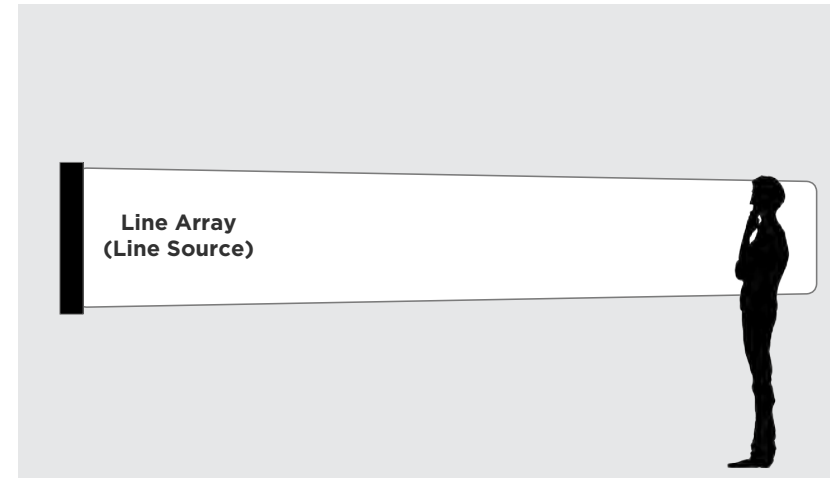
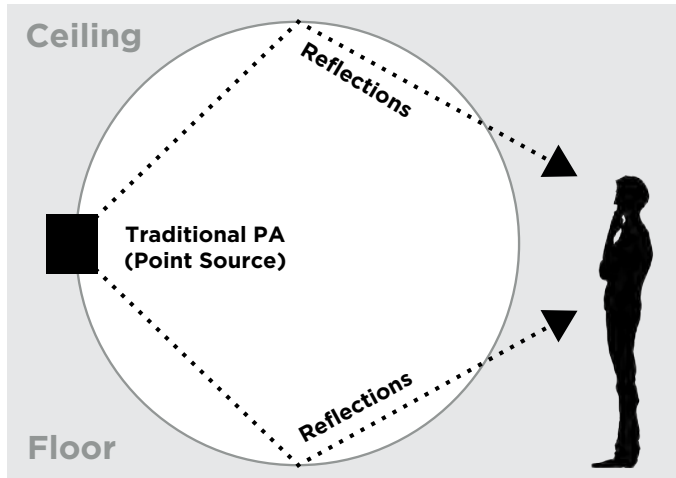

This is accomplished by the patented loudspeaker transducers integrated into the Bose L1 Pro series. They are a stacked set of identical compact drivers arrayed in a straight vertical line. They are engineered to be closely spaced and operating in phase with equal amplitude. The drivers will acoustically interact and couple together changing the sound waveform into a single cylindrical waveform known as line source or line array. This acoustical interaction creates multiple advantages that are explained on the following pages.

THE ADVANTAGES

1
Directs sound to farther distances

2
Overcomes challenging environments

3
Slim adaptable design

4
Lighter weight with easier portability

Each of these advantages will be further explained over the next pages

Line Source Behavior

The L1 Pro systems implement the benefits of line source technology while maintaining portability as an audio solution. The result of this innovation allows for sound to propagate further than a standard point source system. This happens because a line source system is not bound to the inverse square law within the near field critical distance. Traditionally a point source will lose 6dB of sound pressure (SPL) per doubling of distance. The L1 Pro32 + Sub 2 only loses 3dB SPL per doubling of distance for the first eight meters. This allows the system to direct sound to further distances than a standard point source loudspeaker system.

The chart below illustrates the differences between the L1 Pro models in relation to their throw distance. This is the main differentiator between the L1 Pro systems. No matter your venue size, there is an L1 Pro system to fit your needs.

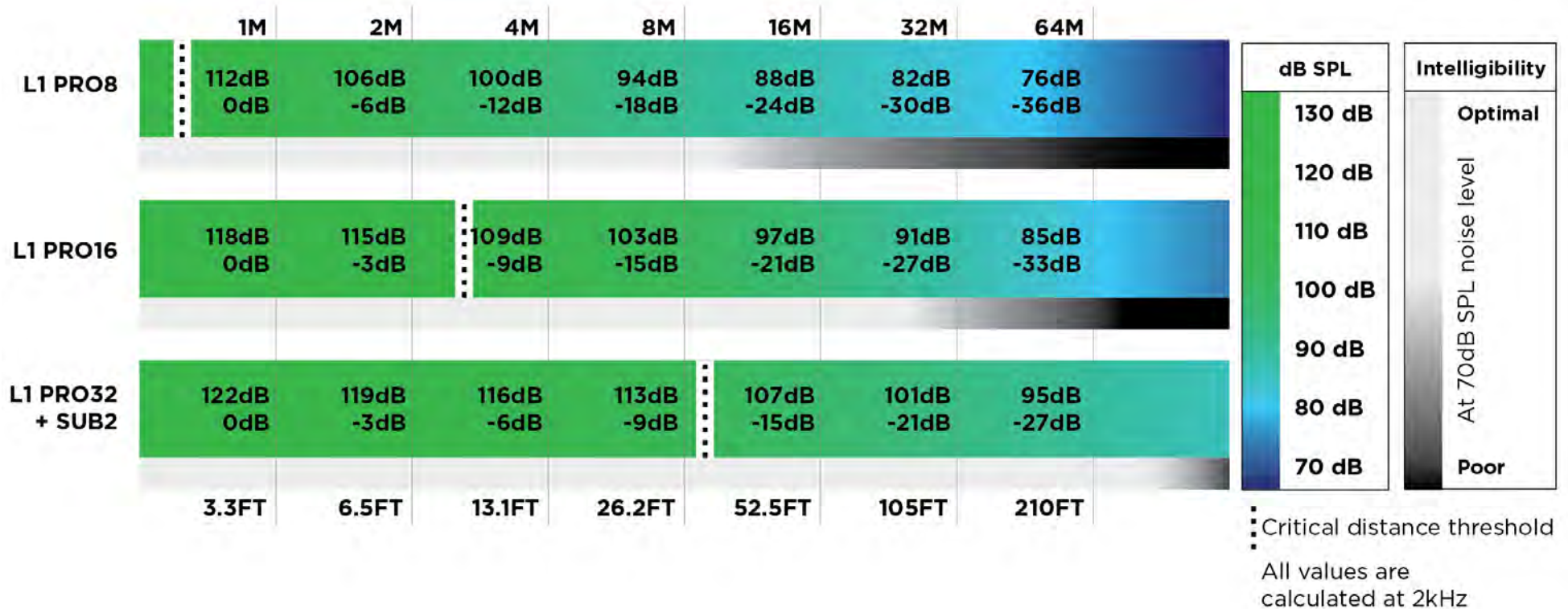

Vertical Coverage

The L1 Pro line of PA systems is comprised of three different coverage patterns.

The L1 Pro 8 system is equipped with a C-Shaped array vertical coverage pattern. This allows it to have the widest coverage of all L1 Pro systems but the shortest throw distance. This makes it suitable for smaller venues or more unique placement situations that require an extremely flexible PA system where a stage may not be present.

The L1 Pro16 system is tailored towards medium sized performance spaces where the performer is usually located above the crowd. It's J-Shape array allows for a farther throw distance than the L1 Pro 8 while still having a wide vertical pattern to maintain flexibility.

The L1 Pro32 system is designed for maximum throw distance in larger venues. This system's straight array shape throws deep into the crowd to give the widest possible audience range a consistent sonic experience.

L1 Pro8

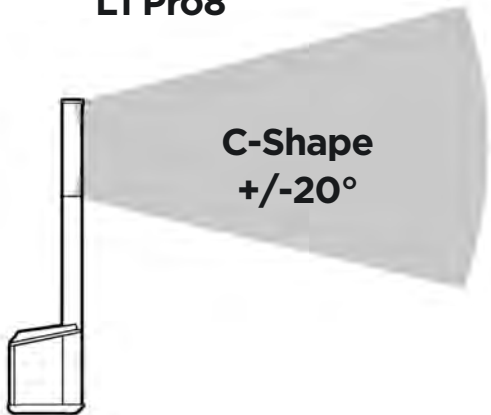

L1 Pro16

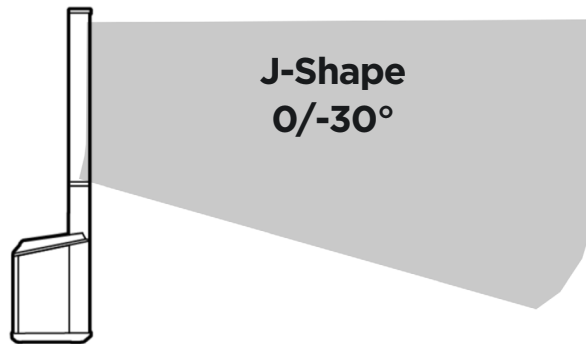

L1 Pro32

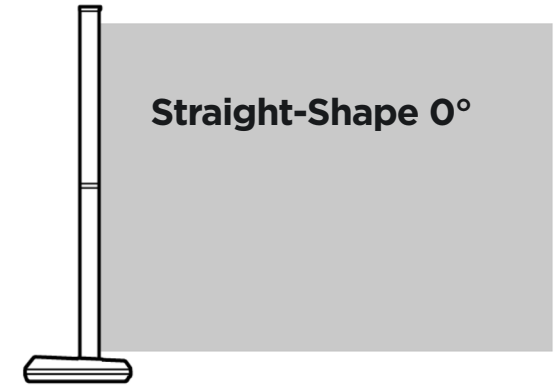

Horizontal Coverage



The L1 Pro line of PA systems feature Bose's stand out articulated array innovation. The articulated array included in all L1 Pro models is made of stacked 2" "Cricket" drivers that are splayed from left to right. This technology enables an extremely wide, true 180-degree horizontal coverage pattern while maintaining a tight engineered vertical coverage pattern. This wide horizontal coverage pattern is perfect for the traveling musician or presenter that requires a fast setup while still being able to reach all audience members in the performance space.

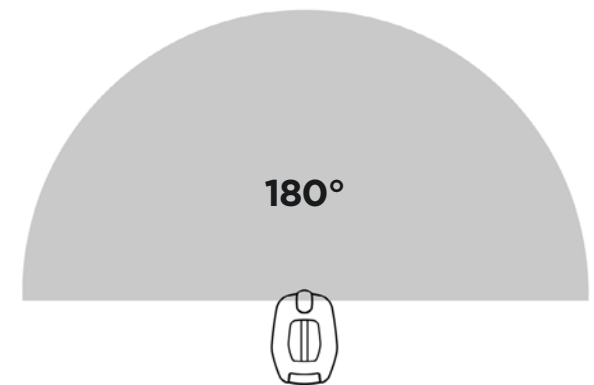

The L1 Pro8 and Pro16 have optional extensions for use when a stage is not present. This allows for a fantastic audio experience at both a local coffee shop or performance venue and extreme flexibility for PA placement in challenging environments.

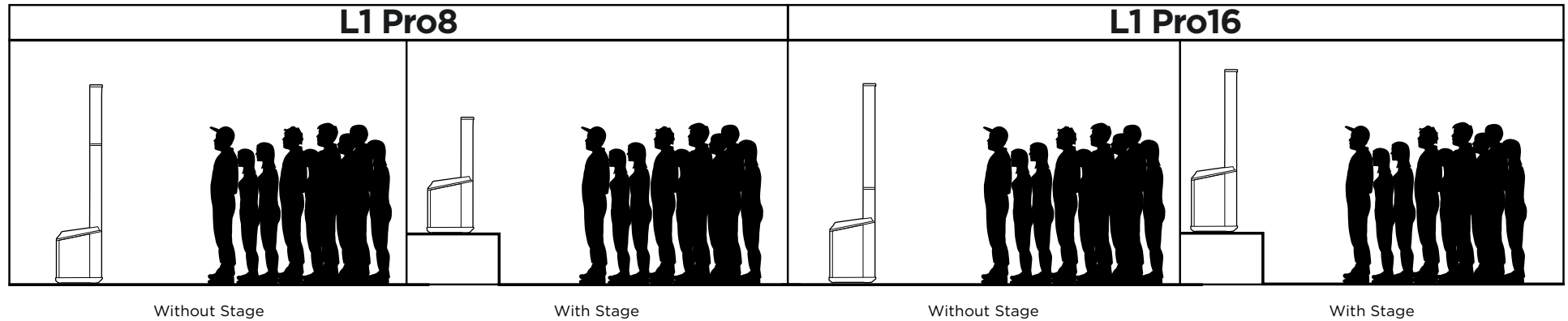

Lighter weight with easier portability

The L1 Pro systems allow for the benefit of line source technology to be brought anywhere. Each system breaks down into compact components that fit into included carrying cases and slip covers. Once the system has been broken down it can then be easily carried into the venue. The chart below explores the weight distribution for each of the four main system configurations. This weight distribution allows for more comfortable and safer transportation of the system from the vehicle to the venue.

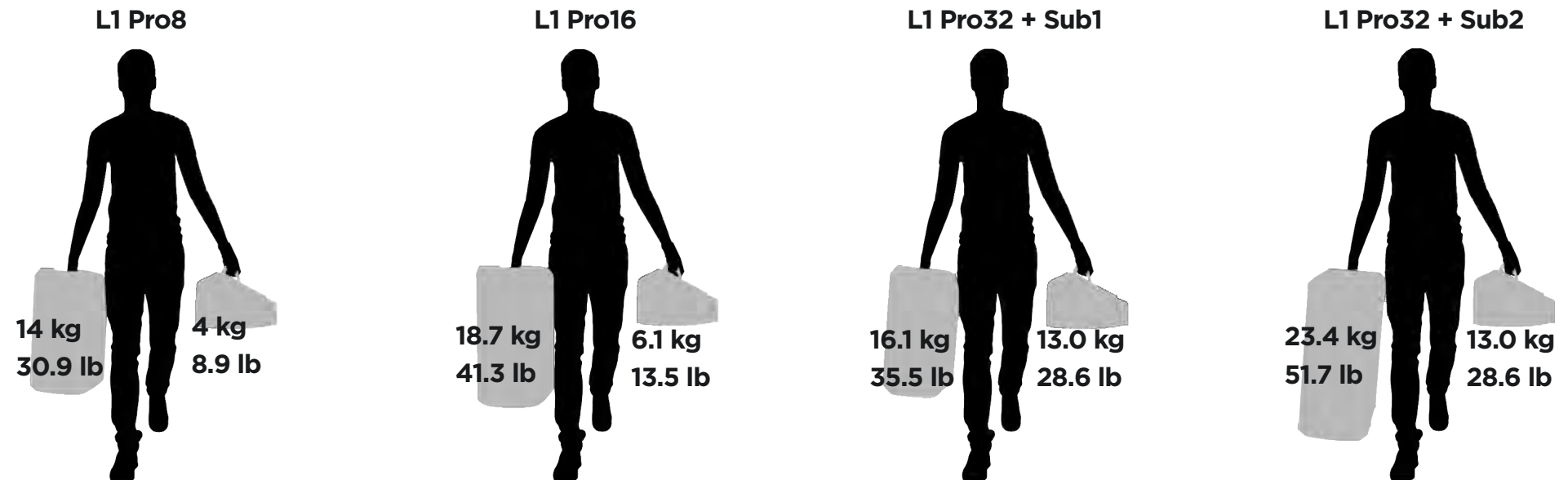

SELECTION GUIDE

L1 PRO SERIES

	L1 PRO8	L1 PRO16	L1 PRO32 + SUB1	L1 PRO32 + SUB2
Loudspeaker Type	8 x articulated cricket drivers w/ integrated 7" x 13" racetrack transducer	16 x articulated cricket drivers w/ integrated 10" x 18" neodymium racetrack transducer	32 x articulated cricket drivers w/ modular 7" x 13" racetrack transducer	32 x articulated cricket drivers w/ modular 10" x 18" neodymium racetrack transducer
Max SPL	112 dB (cont.) 118 dB (peak)	118 dB (cont.) 124 dB (peak)	117 dB (cont.) 123 dB (peak)	122 dB (cont.) 128 dB (peak)
Low-Frequency	45 Hz	42 Hz	40 Hz	37 Hz
Coverage	180° H x +/-20° V	180° H x 0/-30° V	180° H x 0° V	
Vertical Beam Type	C-shape	J-shape	Straight-shape	
Amplifier Design	Class D, 60W mid-high array + 240W sub	Class D, 250W mid-high array + 1000W sub	Class D, 480W mid-high array + 480W sub	Class D, 480W mid-high array + 1000W sub
Onboard Mixer	3 channel			
Inputs				
Channel 1 and 2 Input Type	Combination XLR or 1/4" TRS connector (mic/instrument/line)			
Channel 1 and 2 Features	Volume, Treble, Bass, Reverb, Mute, Phantom power, ToneMatch presets			
Channel 3 Input Type	1/8" TRS (stereo-summed, line), 1/4" TRS (line), Bluetooth audio streaming (AAC)			
Channel 3 Features	Volume, Treble, Bass, Mute			
Phantom Power	Yes			
Bluetooth Streaming	Yes			
SUB1 SUB2 Inputs				
Channel 1 and 2 Type	Not applicable	Not applicable	Combination XLR or 1/4" TRS connector (line) SubMatch in	
Outputs				
Line Out	XLR connector (full frequency bandwidth)			
ToneMatch Port	Compatible with Bose T4S and T8S Mixer			
SubMatch Connection	Not applicable	Not applicable	Yes, cable included	
SUB1 SUB2 Outputs				
Line Outputs	Not applicable	Not applicable	2 x XLR connector (full frequency bandwidth) SubMatch thru	
System Control				
Onboard	Yes			
Wireless	Yes, via L1 Mix app over Bluetooth LE connection			
Other				
System Includes	1 x mid-high array 1 x array extension Subwoofer power stand AC power cord Carry bag	1 x mid-high array 1 x array extension Subwoofer power stand AC power cord Carry bag	2 x mid-high array Sub1 SubMatch cable AC power cord Carry bags Slip cover	2 x mid-high array Sub2 SubMatch cable AC power cord Carry bags Slip cover
Dimensions (H x W x D)	200.5 x 31.8 x 44 cm (78.9 x 12.5 x 17.3 in)	201.2 x 35.5 x 45.6 cm (79.2 x 14.0 x 18.0 in)	L1 PRO32: 213.5 x 34.5 x 55 cm (84.1 x 13.6 x 21.7 in) SUB1: 53.0 x 25.0 x 53.0 cm 20.9 x 9.8 x 20.9 in SUB2: 69.0 x 30.5 x 55.0 cm 27.2 x 12.0 x 21.7 in	
Net Weight	18 kg (39.8 lb)	24.8 kg (54.8 lb)	L1 PRO32: 13.0 kg (28.6 lb) SUB1: 16.1 kg (35.5 lb) SUB2: 23.4 kg (51.7 lb)	

The most portable system

The L1 Pro8 is ready whenever you are, enabling easier load-in and faster setup. With an eight-driver articulated C-shape line array, the L1 Pro8 offers 180 degrees of horizontal sound coverage, equipping singer-songwriters and DJs for small venues like coffee shops and cafes.

Mid High Array

C-shaped line array featuring 8 articulated 2" neodymium drivers; 180-degree horizontal coverage with wide vertical dispersion, allowing your audience to hear clearly whether they are seated or standing, even off to the extreme sides in small venues.

Extension

Provides dual height positions for the mid high array to achieve optimal ear height. Use extension when placed on the ground or floor. Possibly remove extension when placed on elevated platform like a stage or table.

Integrated subwoofer

Featuring a high-excursion 7" x 13" RaceTrack driver; performance that rivals a conventional 12" woofer.



Built-in mixer

The back of the subwoofer incorporates a powered mixer that connects various audio sources with two combo XLR-1/4" phantom-powered inputs, 1/4" and 1/8" (3.5 mm) aux input, plus Bluetooth® streaming — and access channel volume, tone, and reverb via illuminated controls, with ToneMatch presets and system EQ.

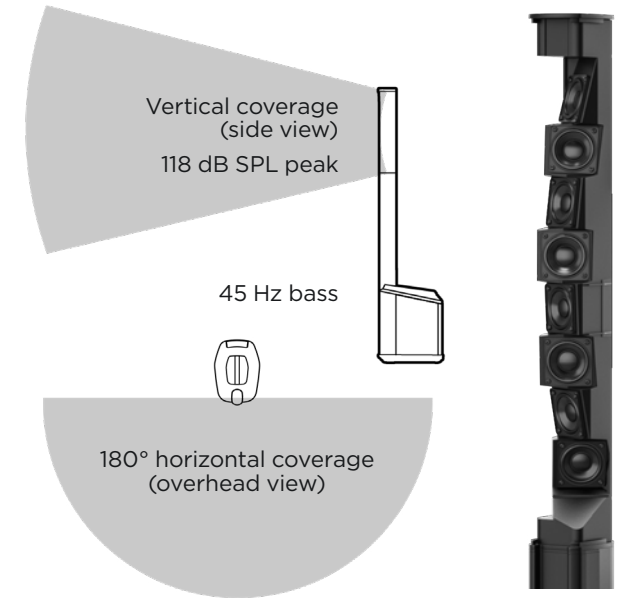

Specifications	L1 PRO8
Loudspeaker Type	8 x articulated cricket drivers w/ integrated 7" x 13" racetrack transducer
Max SPL	112 dB (cont.) 118 dB (peak)
Low-Frequency	45 Hz
Coverage	180° H x +/-20° V
Vertical Beam Type	C-shape
Amplifier Design	Class D, 60W mid-high array + 240W sub
Onboard Mixer	3 Channel
System Includes	1 x mid-high array 1 x array extension Subwoofer power stand AC power cord Carry bag
Dimensions (H x W x D)	200.5 x 31.8 x 44 cm (78.9 x 12.5 x 17.3 in)
Net Weight	18 kg (54.8 lb)

A balance of power and portability

The L1 Pro16 is a streamlined system with high output and extended low frequency. With a 16-driver articulated J-shape line array, the L1 Pro16 offers 180 degrees of horizontal sound coverage and is a perfect fit for DJs, singer-songwriters, and small ensembles performing in small-to-medium sized clubs, bars, and other venues.



Mid High Array

J-shaped line array featuring 16 articulated 2" neodymium drivers; 180-degree horizontal coverage, tight vertical control on top, wide dispersion on the bottom to cover audiences whether setup on the ground or an elevated stage, and even off to the extreme sides in small-to-medium venues.

Extension

Provides dual height positions for the mid high array to achieve optimal ear height. Use extension when placed on the ground or floor. Possibly remove extension when placed on elevated platform like a stage or table.

Integrated subwoofer

Featuring a high-excursion 10" x 18" neodymium RaceTrack driver; performance that rivals a conventional 15" woofer.



Built-in mixer

The back of the subwoofer incorporates a powered mixer that connects various audio sources with two combo XLR-1/4" phantom-powered inputs, 1/4" and 1/8" (3.5 mm) aux input, plus Bluetooth® streaming — and access channel volume, tone, and reverb via illuminated controls, with ToneMatch presets and system EQ.

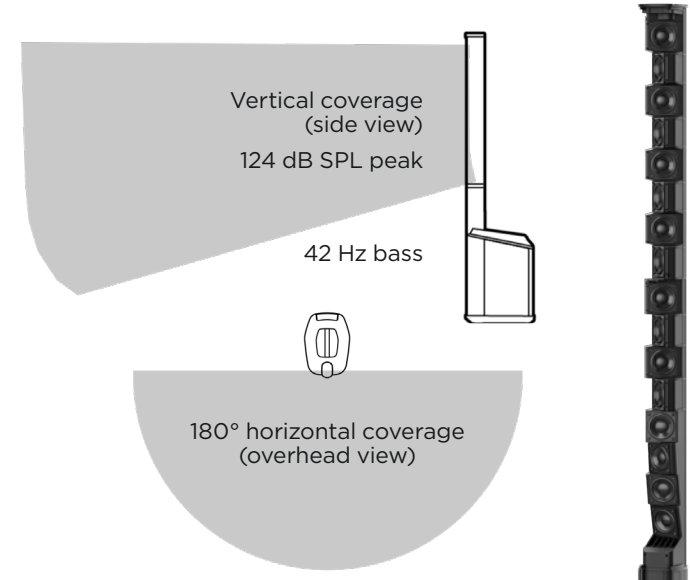

Specifications	L1 PRO16
Loudspeaker Type	16 x articulated cricket drivers w/ integrated 10" x 18" neodymium racetrack transducer
Max SPL	118 dB (cont.) 124 dB (peak)
Low-Frequency	42 Hz
Coverage	180° H x 0/-30° V
Vertical Beam Type	J-shape
Amplifier Design	Class D, 250W mid-high array + 1000W sub
Onboard Mixer	3 Channel
System Includes	1 x mid-high array 1 x array extension Subwoofer power stand AC power cord Carry bag
Dimensions (H x W x D)	201.2 x 35.5 x 45.6 cm (79.2 x 14.0 x 18.0 in)
Net Weight	24.8 kg (54.8 lb)

The most advanced L1 ever

For DJs, singer-songwriters, bands — and your audience — the L1 Pro32 delivers a truly superior experience. With the supreme clarity and output of a 32-driver articulated line array, the L1 Pro32 offers 180-degree horizontal sound coverage, giving you an unrivaled portable PA system for medium-to-large-sized venues and events like weddings, clubs, hotel ballrooms, festivals, and more.

Mid High Array

Straight line array, featuring 32 articulated 2" neodymium drivers; 180-degree horizontal coverage with the highest SPL, longest throw distance, and most focused coverage pattern in an L1 ever — providing intricate sonic detail, clarity, and consistency, even off to the extreme sides in larger venues.

Modular Sub1 subwoofer

Featuring a high-excursion 7" x 13" RaceTrack driver with performance that rivals a conventional 12" woofer. Bass response down to 40Hz.



Built-in mixer

The power stand incorporates a powered mixer that connects various audio sources with two combo XLR-1/4" phantom-powered inputs, 1/4" and 1/8" (3.5 mm) aux input, plus Bluetooth® streaming — and access channel volume, tone, and reverb via illuminated controls, with ToneMatch presets and system EQ.



Included SubMatch cable

A single cable connectivity for both power and audio.

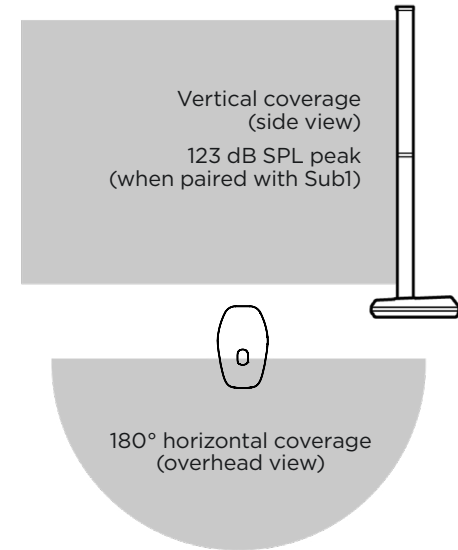

Specifications	L1 PRO32 + SUB1
Loudspeaker Type	32 x articulated cricket drivers w/ modular 7" x 13" racetrack transducer
Max SPL	117 dB (cont.) 123 dB (peak)
Low-Frequency	40 Hz
Coverage	180° H x 0° V
Vertical Beam Type	Straight-shape
Amplifier Design	Class D, 480W mid-high array + 480W sub
Onboard Mixer	3 Channel
System Includes	2 x Mid-high array SUB1 SubMatch cable AC power cord Carry bags Slip cover
Dimensions (H x W x D)	L1 PRO32: 213.5 x 34.5 x 55 cm (84.1 x 13.6 x 21.7 in) Sub1: 53.0 x 25.0 x 53.0 cm (20.9 x 9.8 x 20.9 in)
Net Weight	L1 PRO32: 13.0 kg (28.6 lb) Sub1: 16.1 kg (35.5 lb)

The most powerful L1 ever

For DJs, singer-songwriters, bands — and your audience — the L1 Pro32 delivers a truly superior experience. With the supreme clarity and output of a 32-driver articulated line array, the L1 Pro32 offers 180-degree horizontal sound coverage, giving you an unrivaled portable PA system for medium-to-large-sized venues and events like weddings, clubs, hotel ballrooms, festivals, and more.

Mid High Array

Straight line array, featuring 32 articulated 2" neodymium drivers; 180-degree horizontal coverage with the highest SPL, longest throw distance, and most focused coverage pattern in an L1 ever — providing intricate sonic detail, clarity, and consistency, even off to the extreme sides in larger venues.

Modular Sub2 subwoofer

Featuring a high-excursion 10" x 18" neodymium RaceTrack driver with performance that rivals a conventional 15" woofer. Bass response down to 37Hz.



Built-in mixer

The power stand incorporates a powered mixer that connects various audio sources with two combo XLR-1/4" phantom-powered inputs, 1/4" and 1/8" (3.5 mm) aux input, plus Bluetooth® streaming — and access channel volume, tone, and reverb via illuminated controls, with ToneMatch presets and system EQ.



Included SubMatch cable

A single cable connectivity for both power and audio.

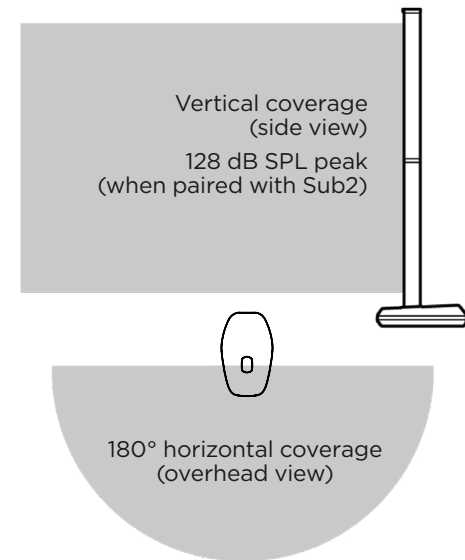

Specifications	L1 PRO32 + SUB2
Loudspeaker Type	32 x articulated cricket drivers w/ modular 10" x 18" neodymium racetrack transducer
Max SPL	122 dB (cont.) 128 dB (peak)
Low-Frequency	37 Hz
Coverage	180° H x 0° V
Vertical Beam Type	Straight-shape
Amplifier Design	Class D, 480W mid-high array + 1000W sub
Onboard Mixer	3 Channel
System Includes	2 x Mid-high array Sub2 SubMatch cable AC power cord Carry bags Slip cover
Dimensions (H x W x D)	L1 PRO32: 213.5 x 34.5 x 55 cm (84.1 x 13.6 x 21.7 in) Sub2: 69.0 x 30.5 x 55.0 cm (27.2 x 12.0 x 21.7 in)
Net Weight	L1 PRO32: 13.0 kg (28.6 lb) Sub2: 23.4 kg (51.7 lb)

Bass without the bulk

A powered, portable bass module, the Sub1 or Sub2 subwoofer combines with virtually any portable PA and delivers low-end performance down to 40 Hz or 37 Hz respectively. Sub1 is the more compact subwoofer option for the Bose L1 Pro32, combining seamlessly via single-cable SubMatch connectivity. Sub2 is the more powerful option.



M20 Threaded Insert

The Sub1 and Sub2 are designed to complement your L1 Pro32 system. Each sub can also be paired with a Bose S1 Pro system to create a micro-PA.

The included M20 threaded insert is designed to work with the optional Sub1/Sub2 Adjustable Speaker Pole accessory.

This allows you to mount an S1 Pro or other point source loudspeaker weighing 15.4 kg (34 lb) or less, anywhere between 34 and 52 inches high.

Rotatable Logo

The Bose logo can be rotated when the subwoofer is placed in the horizontal orientation.



Specifications	SUB1	SUB2
Loudspeaker Type	7" x 13" RaceTrack Driver	10" x 18" neodymium RaceTrack Driver
Low-Frequency	40 Hz	37 Hz
Amplifier Design	Class D, 480W	Class D, 1000W
Inputs	2 x Combination XLR or 1/4" TRS connector (line) SubMatch	
Outputs	2 x XLR connector (line) SubMatch Thru	
Controls	Level Phase/Pattern (cardioid mode) Line In EQ Line out EQ	
Dimensions (H x W x D)	53.0 x 25.0 x 53.0 cm 20.9 x 9.8 x 20.9 in	69.0 x 30.5 x 55.0 cm 27.2 x 12.0 x 21.7 in
Net Weight	16.1 kg (35.5 lb)	23.4 kg (51.7 lb)
Includes	Slip cover AC power cable	

Sub connection configurations

Included SubMatch cable

A single cable connectivity for both power and audio. This innovation allows for a simpler and faster setup when using an L1 Pro32 system + a Sub1 or Sub2. The color coded cable connectors and keyed ports make the setup of the most powerful L1Pro system plug and play.

This cable also allows for more than one subwoofer to be used when more low frequency reproduction is needed. Simply plug in a second Sub1 or Sub2 and perform.



Flexible bass for any system

When not connected to an L1 Pro32 system, the Sub1 or Sub2's on-board inputs can be used to sum a stereo input for low frequency reproduction and pass stereo content out of line out 1 and 2 to stereo Mid High content back out to additional loudspeakers.

This stereo content can be passed as full frequency or altered by the optional high pass filter located on the line out EQ.

Bass where you want it

A cardioid sub configuration allows for a coverage pattern that is not unlike a cardioid microphone pickup pattern. This coverage pattern allows for most of the sound energy to be focused in front of the sub module stack while drastically reducing the sound energy that is propagated behind the subwoofer stack.

This contrasts with a standard subwoofer configuration that will act in an omnidirectional coverage pattern where sound energy propagates equally in all directions for the sub module. The main benefit of the cardioid setup is that the low frequency sound energy from your performance will be focused on the audience and not back onto the stage. This is especially helpful when amplifying large resonant acoustic instruments like drums or an upright bass. This coverage pattern is achieved by changing the direction of the second sub module driver and time aligning it using a small delay to the front facing sub module driver. This will create destructive interference behind the sub stack and results in phase cancellation of the sound energy while creating constructive interference between the modules in front of the sub stack resulting in phase summation and increased sound energy.

To accomplish this, stack two matching sub modules on top of one another as shown here. Make sure that the module facing away from the audience is at the bottom of your stack. This configuration allows for a 10 dB SPL down point located directly behind the subwoofer stack. This configuration is possible with both the Sub1 and Sub2 modules when stacked with an identical module as seen to the left. This can be accomplished without any extra AC power runs thanks to the SubMatch cabling innovation that transmits both power and audio signal to the second subwoofer module.

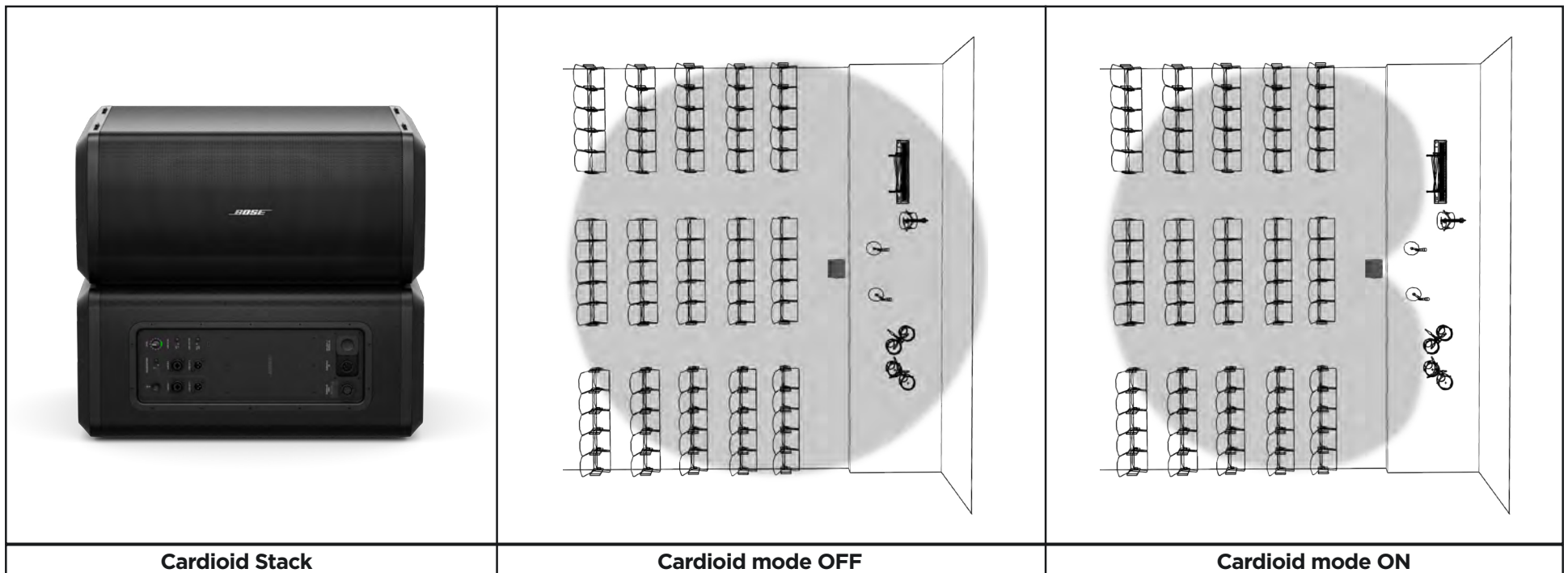

Connecting and setting up

To configure cardioid subs, stack two identical modules as seen to the left, connect the top sub module to an L1 Pro32 via a SubMatch cable or an external source and A/C power. Next set the top sub to positive polarity and the bottom sub to cardioid mode by pressing and holding the polarity button until the CARDIOID LED is illuminated.

Make sure that the **LEVEL** settings are matched across the sub modules as mismatching them will skew the performance of cardioid mode. Once this setup has been completed a 10dB down point will be present directly behind the sub stack. This performance will be extremely beneficial if your performance includes any large resonant instruments such as an upright bass or a drum set.

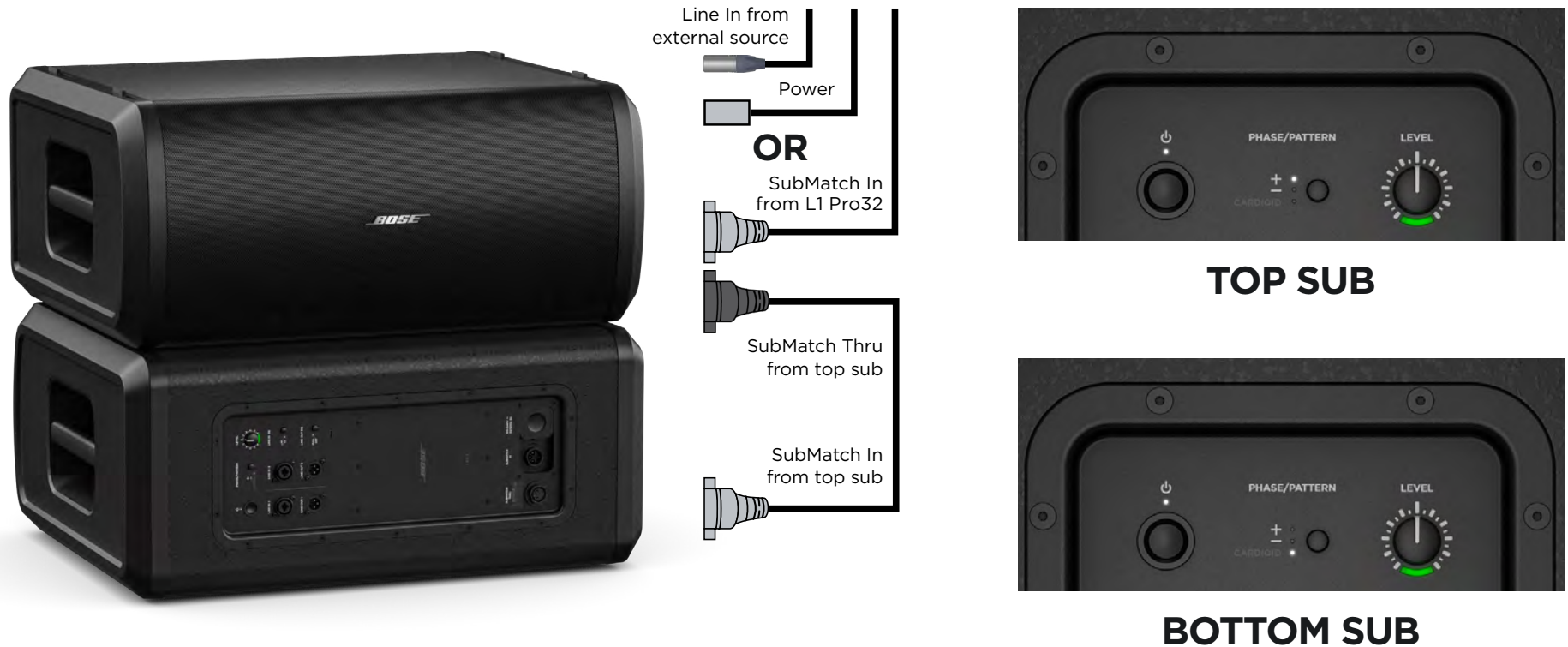

With the ultra-portable L1 Pro8 for intimate venues, the portable-with-punch L1 Pro16 for small-to-medium spaces, and the peak-performance L1 Pro32 for larger audiences, there's an ideal system for almost any venue.

	Venue	Recommended System	Possible Applications			
Entertainment	Parties Outdoor events Karaoke	L1 Pro8	Backyard parties Special family events	Football parking lot tailgating	Karaoke parties	DJ amplification
		L1 Pro16	Outdoor amateur sports events Theatrical production, soundstage/sound effect (SFX)			
		L1 Pro32				
Education	Classrooms Auditoria Gymnasias Cafeterias Outdoors	L1 Pro8	Mobile multimedia carts	Classroom presentations	Listening to a blog or podcast	Interactive displays
		L1 Pro16	Rallies, sporting events, and speeches	Plays and indoor performances	Announcements and music at practices	Emergency preparedness drills
		L1 Pro32				
Hospitality	Ballrooms Conference rooms Meeting rooms Hotel common areas	L1 Pro8	Special event, anniversary Presentation or speech at a banquet or corporate meeting Bookstore, café		Business presentation	
		L1 Pro16			Conference room meeting Outdoor cocktail party	
		L1 Pro32				
House of Worship	Indoor public address Lobby and hallways Youth rooms Classrooms and offices Portable church	L1 Pro8	Retreats and mission work Backline for worship band, Youth events Music worship		Activity room/Sm. function room	Memorial services
		L1 Pro16			Raffles, bingo games, or other events	
		L1 Pro32				
Business and Civic	Offices Public address Training/classes Meetings	L1 Pro8	Corporate presentations	Briefings, press events, and training exercises, municipal auctions	Training and demonstration	Portable crowd control or public address
		L1 Pro16	Public speaking, announcement Outdoor community events, community theater		Radio remote broadcast at a large concert or event	
		L1 Pro32				
Fitness	Gyms Yoga Studios Dance Studios Karate Studios Spin Studios	L1 Pro8	Voice Amplification		Background Level Music	
		L1 Pro16	High Level Music Playback with Instructor Voice Amplification		Gymnasium Music Playback and Voice Amplification	
		L1 Pro32				

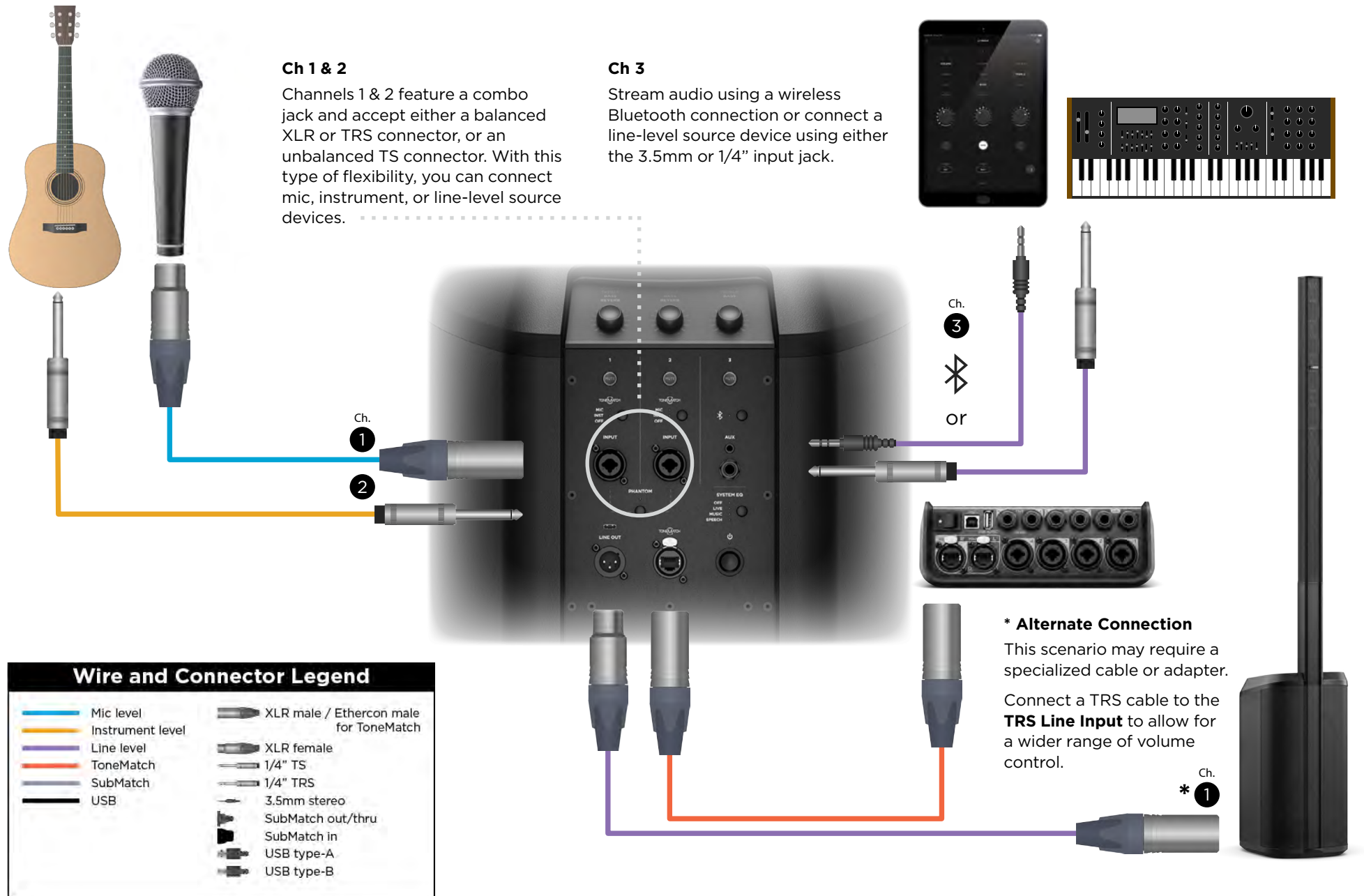

The L1 Pro8 isn't just for singer-songwriters and DJs; presenters need to be heard too. In this example, the wireless mic receiver can be connected to input 1 or 2. A PC laptop for multimedia presentations can connect to channel 3 either using a Bluetooth connection or the 3.5mm aux input. Level adjustments can either be made directly on the built-in mixer or from the L1 Mix app on a mobile phone or tablet.

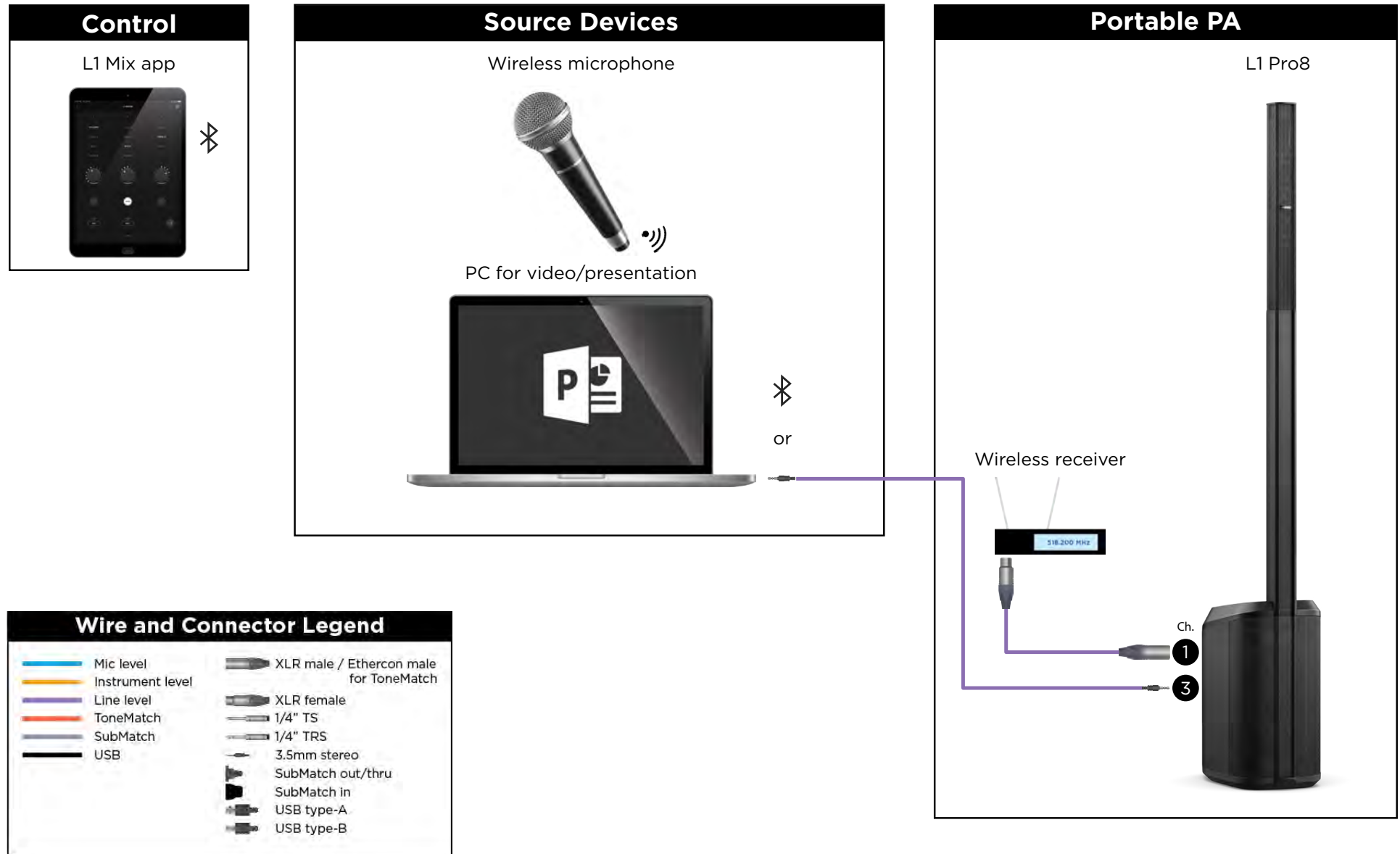

L1 PRO16 SYSTEM DIAGRAM EXAMPLE

L1 PRO SERIES

When the whole band decides to join you, flank the sides of the stage with a pair of L1 Pro16's. Connect up to eight microphones or instruments to the ToneMatch T8S mixer, and use the ToneMatch connection to provide a digital audio connection to one of the L1 Pro16's and power for the ToneMatch mixer. Wire the full bandwidth line out to the second L1 Pro16 for increased audience coverage. Finally, with the T8S mixer's aux sends, you can leverage up to four S1 Pro's for monitors and take up minimal stage real estate.

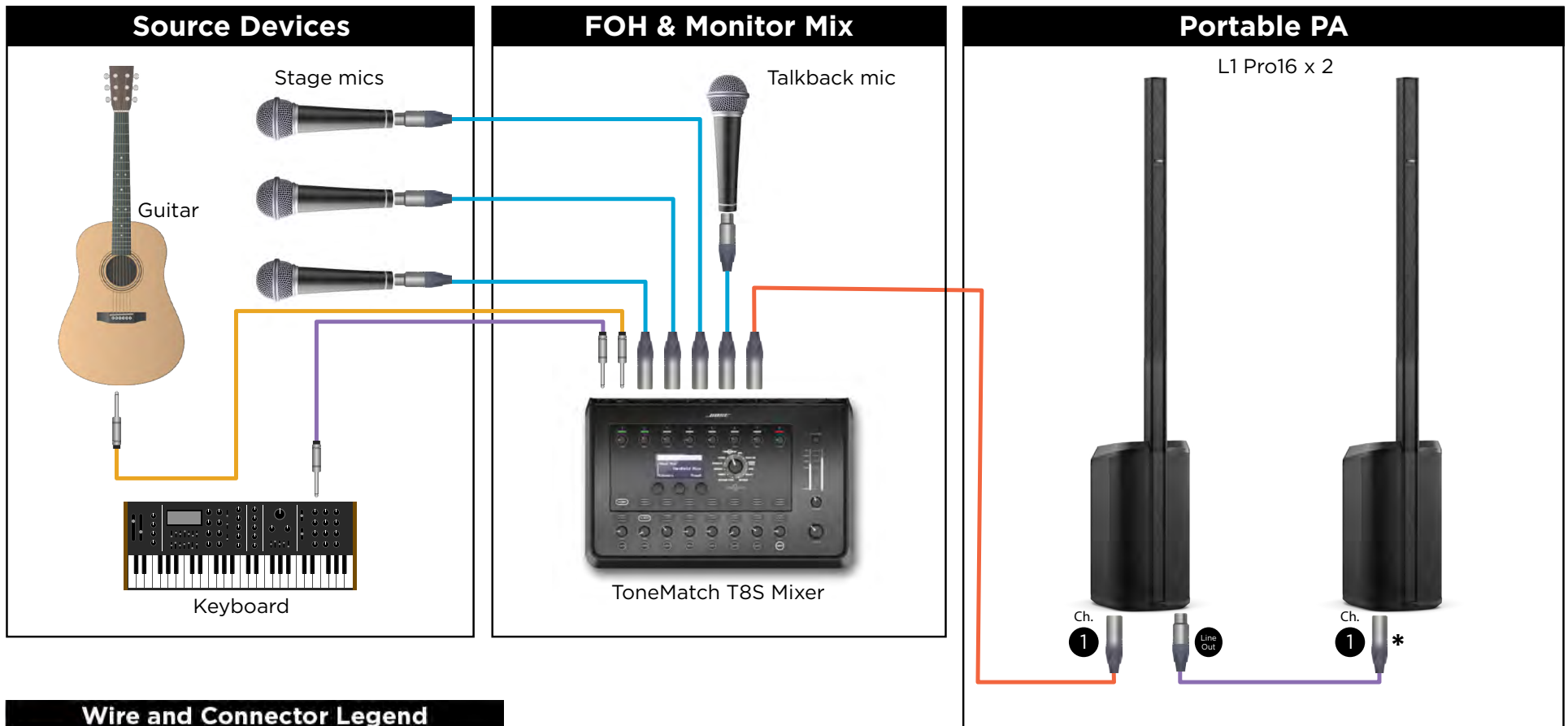

* Alternate Connection

This scenario may require a specialized cable or adapter.

Connect a TRS cable to the **TRS Line Input** to allow for a wider range of volume control.

In this example, the wireless mic receiver can be connected to input 1 or 2 with the free input left for the guitar. A PC laptop loaded with backing tracks can connect to channel 3 either using a Bluetooth connection or the 3.5mm aux input. Use proprietary SubMatch cables for both power and audio to connect your L1 Pro32 and 2x Sub2 modules in cardioid mode for a focused low end on the audience. Don't forget, you can take control of your mix from the L1 Mix app on a mobile phone or tablet.

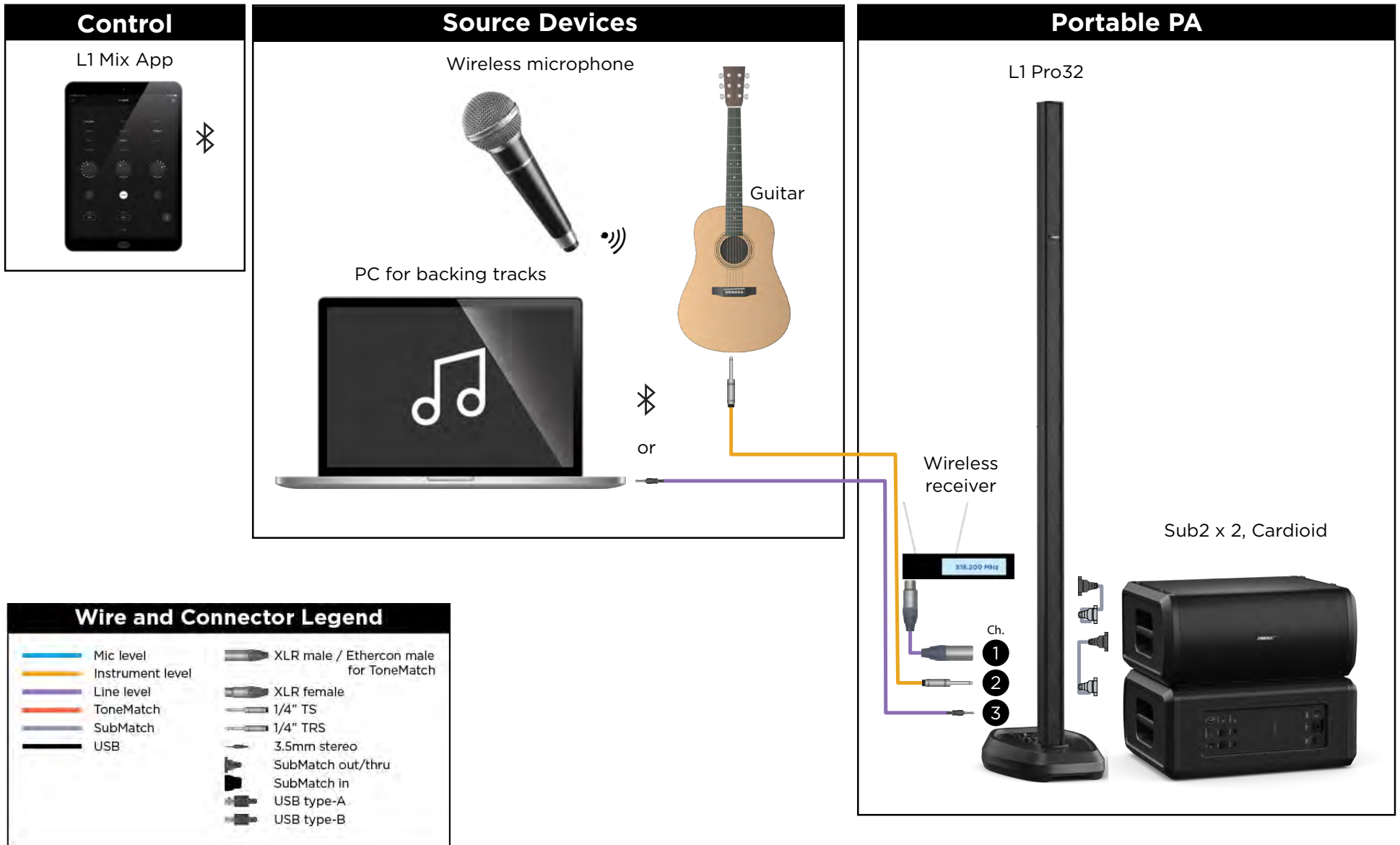

L1 PRO32 SYSTEM DIAGRAM EXAMPLE 2

In this example, the main left and right outputs of a DJ mixer feed line level inputs on stage left and stage right L1 Pro32 systems. A PC laptop with DJ software and additional music tracks connect to the DJ mixer over a USB cable. While the L1 Pro32 system can easily accommodate a microphone, it is instead connected to one of the DJ mixer's mic preamps so that it may be routed to the master and on to both L1 Pro32 systems. In this configuration, Sub1 modules are connected to their respective L1 Pro32 systems via the provided SubMatch cable. The L1 Mix app on a mobile phone or tablet provides convenient access for walking about the venue to choose the optimal system EQ.

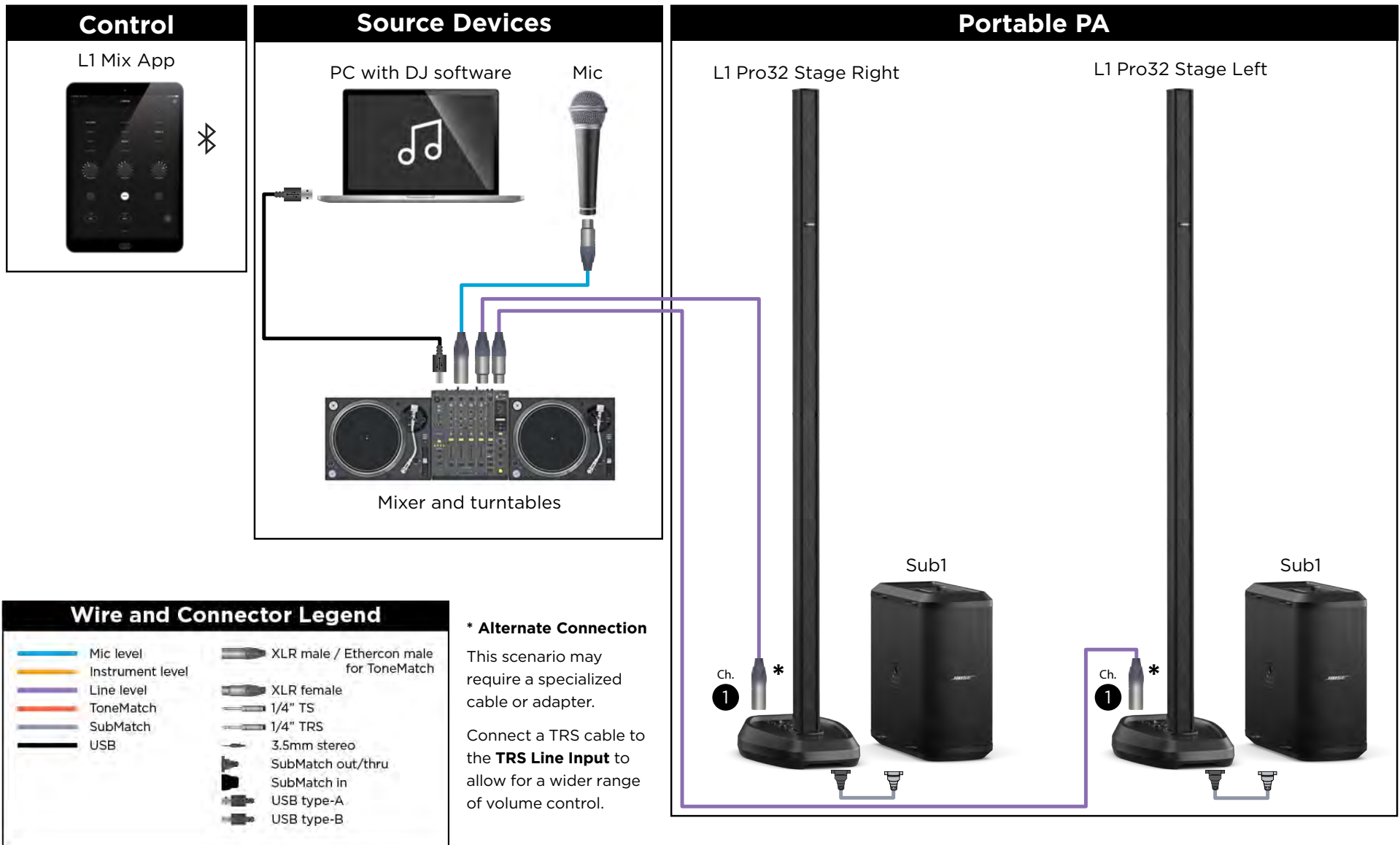

Expand your system

Take control of your music with T4S and T8S ToneMatch® mixers, compact 4 and 8 channel interfaces designed for performers. Engineered with powerful DSP engines and intuitive user controls, they offer studio-quality EQ, dynamics and effects processing. Sound great with integrated Bose® ToneMatch® processing and zEQ, especially when connected to a Bose L1 Pro system for full end-to-end tonal control. Play confidently on stage with these rugged ToneMatch mixers using tactile controls, easy-to-read LED displays and scene recall. ToneMatch mixers, the ultimate on-stage companions for performing artists.

Convenient gig-ready features

Rugged enclosure with a protective magnetic cover to protect controls and connectors

Includes a ToneMatch cable for connecting to a Bose L1 Pro system for digital audio and power.

Bottom insert allows you to use standard mounting accessories to keep your ToneMatch mixer within reach.



High-density connectivity

Unprecedented connectivity and control in a small digital stereo mixer

Four (T4S) or eight (T8S) high-quality audio preamps with XLR-combo jacks for microphones or instruments, and switchable phantom power

Two Aux inputs for additional sources with two (T4S) or four (T8S) Aux sends

USB-A and -B for USB drive playback or PC/Mac interfacing

ToneMatch outputs for digital audio and power.

Balanced ¼" TRS and XLR (T8S only) stereo outputs

Independent headphone output

Powerful audio processing

Updated, studio-quality effects with advanced digital audio processing.

High-quality effects include compressor, limiter, de-esser, noise gate, chorus, flanger, phaser, tremolo, delay, and reverb.

Bose® ToneMatch® processing for natural-sounding vocals and instruments.

zEQ focuses the sound of ToneMatch presets for effective adjustments on the fly.

Independent ToneMatch, EQ, dynamics and effects per channel.

Dedicated reverb for Aux sends, and a global shared reverb for use across all channels.

Master output EQ helps compensate for venue acoustics.

Full end-to-end tonal optimization when used with Bose L1, L1 Pro, F1 and S1 systems.



These optional accessories are sold separately.

L1 Pro8 System Bag

Holds the complete Bose L1 Pro8 system, including the power stand

Padded lining, rubber footing, and heavy-duty zipper

Comfortable shoulder strap and handle

Extra room inside to carry microphones, cables, and more

Durable, lightweight design makes your L1 Pro8 even more portable

Available in black



L1 Pro8/L1 Pro16 Slip Cover

Designed for use with Bose L1 Pro8 or Bose L1 Pro16 power stand respectively

Top cutout for easy access to power stand handle

Convenient slip-on design with Bose logo

Available in black



L1 Pro16 System Roller Bag

Holds the complete Bose L1 Pro16 system, including the power stand

Built-in wheels and comfortable handle for easy transport

Padded lining, rubber footing, and heavy-duty zipper

Extra room inside to carry microphones, cables, and more

Durable, lightweight design makes your L1 Pro16 even more portable

Available in black



These optional accessories are sold separately.

L1 Pro32 Array & Power Stand Bag

Holds the Bose L1 Pro32 line array and power stand

Padded lining and heavy-duty zipper

Comfortable shoulder strap and handle

Extra room inside to carry microphones, cables, and more

Durable, lightweight design makes your L1 Pro32 even more portable

Available in black



Sub1/Sub2 Adjustable Speaker Pole

Designed for use with Bose Sub1 or Sub2 powered bass modules

Mount Bose S1 Pro portable PA or other loudspeakers above Sub1 or Sub2

Telescoping capability with locking pin for extension up to 132 cm (52 inches)

Stainless steel with standard male M20 thread

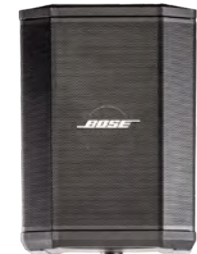

Sub1/Sub2 Roller Bag

Designed for Bose Sub1 or Bose Sub2 powered bass module respectively

Molded EVA shell, padded lining, and heavy-duty zipper

Includes built-in wheels and telescoping handle

Durable, lightweight design makes your Sub1 or Sub2 even more portable

Available in black

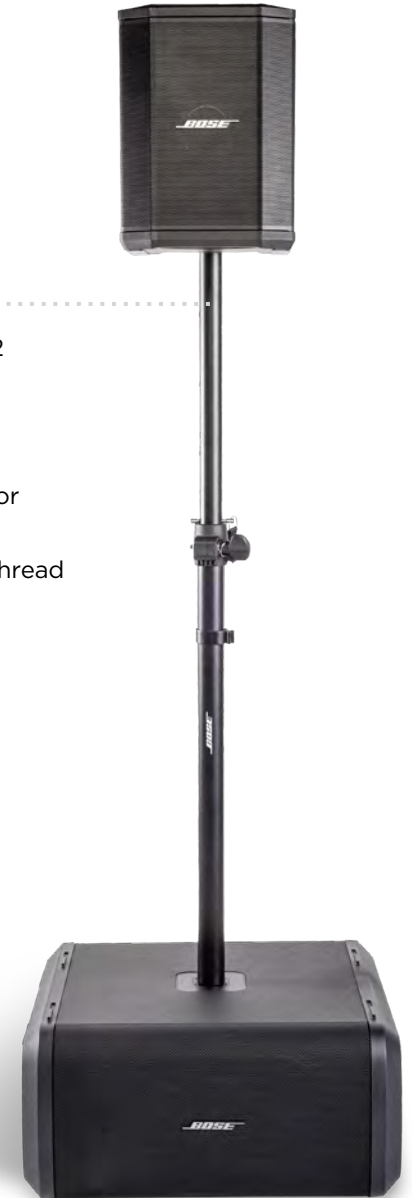

The Bose logo, consisting of the word "BOSE" in a bold, italicized, sans-serif font, is centered within a white square. The square is set against a dark, almost black background.

LEARN MORE AT [PRO.BOSE.COM/L1](https://pro.bose.com/L1)